

Alpha - Fitting Instructions

The installation of Alpha panels is straightforward. Typically three methods of fixing are used;

- Direct adhesion to a substrate
- The use of stand-offs to create an air gap.
- Hanging or suspended using the hanging kits.

Tech materials can supply all the fixing equipment required so please state which fixing method you will be using when ordering.

Before fixing we recommend that the panels are stored flat in the room they are going to be fitted in for 24 hours.

Do not store in the upright or in a curved position.

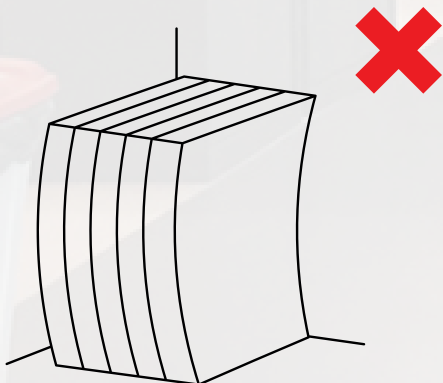
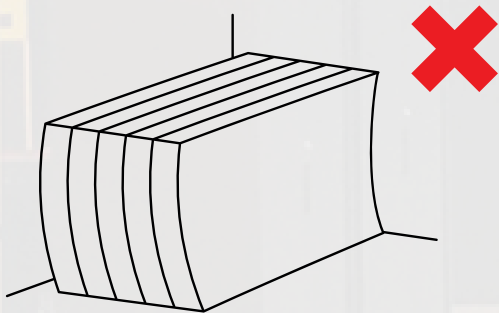
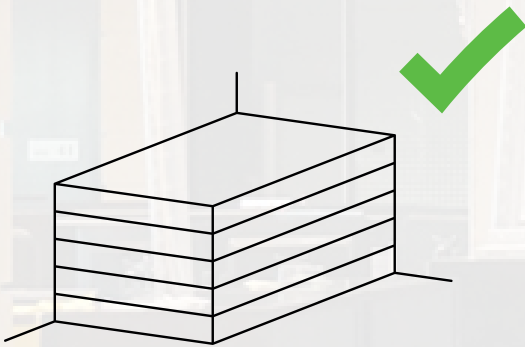

Alpha - Direct Adhesion to Substrate

1. Ensure the substrate you are fixing to is clean, free from dust, grease and oil.
2. The surface that you wish to bond to requires a mechanical bond so need to have a 'tooth' to allow adequate bonding. Some surfaces may require scuffing to create this.
3. If required, prime the surface with an aerosol contact adhesive.
4. Adhesive application – You will require a suitable adhesive such as AC50.
 1. *Cut the nozzle on the applicator so that it dispenses 6mm thick bead.*
 2. *Apply a bead of adhesive around the perimeter of the back face (back face is labelled). No more than 25mm from the edge of the panel.*
 3. *Then apply a line of adhesive using one of the two patterns shown in Fig.1.*
 4. *Apply the panel to the substrate within 20 minutes and monitor your adhesive ensuring it does not start to skin. Set the panels into place and smooth with open clean palms of your hands.*
5. Remove the panel from the substrate and hold it off the surface for one minute. Then reset the panel into place and smooth with firm pressure (you may find the use of a polyurethane float is a useful tool for this) . Use mechanical fasteners if you see the need to help this stay positioned while the adhesive remains wet (these can be removed later).

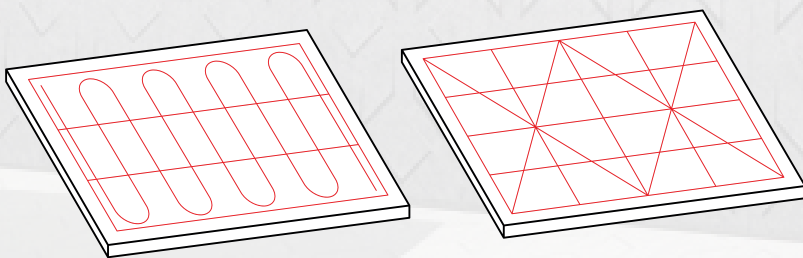

Fig. 1. Adhesive Pattern

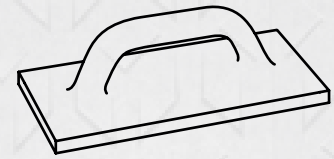

Fig. 2. Polyurethane Float

Notes

- Never use solvent based contact adhesives.
- Install all panels by maintaining the identical orientation for each and every panel installed. Do not reverse or flip panels.
- Ensure you apply the surface to the back face of the panel which is indicated by a sticker.
- If you are in any doubt about the surface you are bonding to, we recommend that you find or create a suitable test area and test the bond before fitting the panels.
- A 6mm bead of adhesive will typically cover 8.2lm.
- If you are unsure of the fitting system that has been specified for your project then we advise that you stop and verify the tails with both your specifier and Tech Materials. While Tech Materials may be able to assist you with common methods of attachment. Others may be unique to your project and need to be discussed directly with the specifier.

Using Standoffs

For aesthetic or technical reasons you may choose to fix your Alpha panels using chrome finished standoffs.

- The standoffs are available in a variety of sizes, materials and finishes.
- The total number of standoffs required per panel is determined by the final dimensions of your panel. Use the illustration shown in Fig.2 to determine the minimum number of standoffs required.
- Note, suitable blocking (chosen in accordance with your length of standoff) is also recommended as a hidden support and method to prevent the panel curving over time (see fig.3.). This is a self-adhesive block for easy fixing and can be supplied by Tech Materials if you specify that you are using standoffs.
- Begin by marking the panel with the placement of each hole for every standoff. No hole should be within 75mm of any perimeter edge of the panel.
- Using a tungsten carbide bit, drill a suitable sized hole through the panels for each standoff placement.

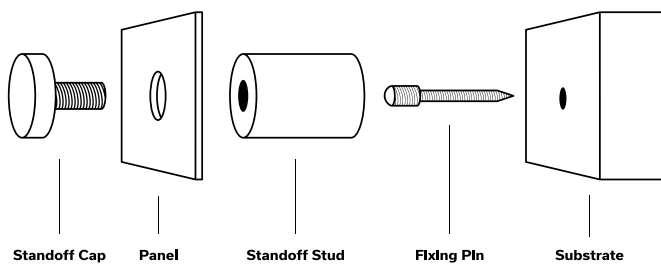
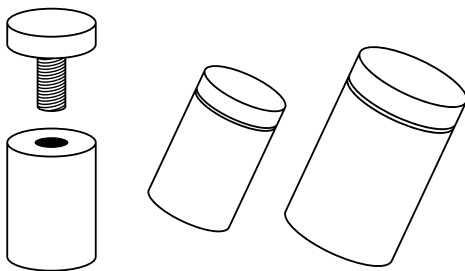

Fig. 3. Standoff Assembly



Using Standoffs

- With all of the panel holes now drilled, determine the precise placement of where the panel is to be installed. With one person holding the panel in place (level and plumb), a second person will mark the substrate with the precise placement of each panel hole.
- Predrill the substrate to allow the fixing of the standoff stud fixing pin. Use the appropriate fixing for the substrate.
- Secure each standoff to its appropriate stud fixing pin which is attached to the wall.
- Set the panel in place over the standoff bases and attached the standoff cap to secure the panel. Tighten only by hand, do not over tighten.

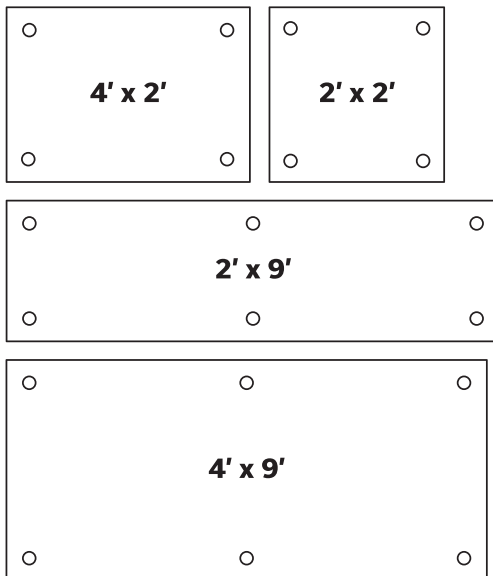

Fig. 4. Hole Placement

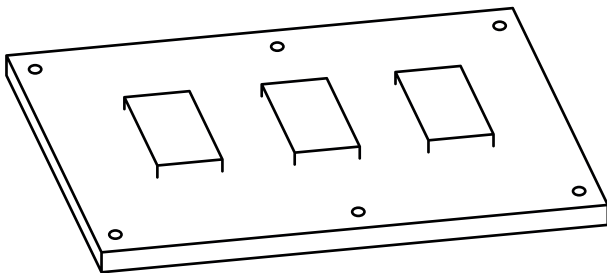

Fig. 5. Spacing Blocks



Notes

- We do not recommend suspending panels from gypsum board without other support.
- If you are unsure of the fitting system that has been specified for your project then we advise that you stop and verify the tails with both your specifier and Tech Materials. While Tech Materials may be able to assist

Hanging or Suspended

Hanging kits for the Alpha panels are sold separately and must be specified at the time of ordering. Each kit consists of a metal pre-drilled L-bracket for the perimeter of the panel and depending on the size of the panel, additional centre support may be required. A wire hanging kit containing wire adjustment piece, length of wire, end swage, barrel and aluminium anchor

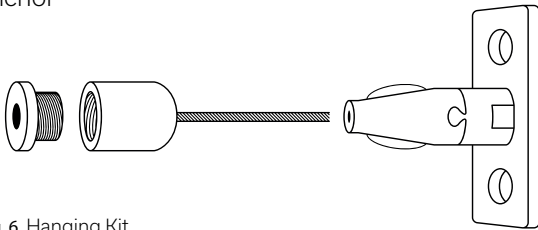

Fig. 6. Hanging Kit

Suspended Panel Assembly

- Begin by laying out the Alpha panel on a clean solid work bench. Placing the panel face down as indicated by the sticker.
- Locate all metal 'L' brackets according to the length of the panel. If you have purchased a non standard panel size you may need to cut the length of the bracket to fit using a hacksaw.
- Once L-bracket placement has been determined according to panel overall dimensions, locate the pre-drilled holes on the L-brackets. These holes will be spaced using 600mm centres and are located on all ends of each L-bracket piece.
- Fix the L-brackets in the correct location using the 6mm M8 screws provided. Screw L-brackets directly onto "non-face side" of panel in the locations marked opposite.
- Using the hanging points on the fixed 'L' brackets as a guide transfer the dimensions to the ceiling substrate.

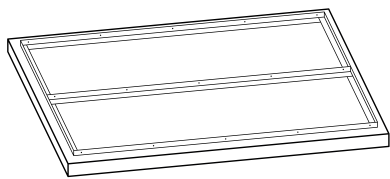

Fig. 7. Hole Placement



Hanging or suspended

Suspended Panel Assembly

- After identifying each corresponding suspension point on the ceiling substrate. Drill and fix the ceiling anchor base plate (a) to the ceiling using a suitable fixing for your substrate.
- Locate the wire (c) that is connected to the ceiling anchor (b) Pass this free end of the wire through the grippe adjuster block, then loop it through the predrilled suspension point on the 'L' bracket and back through the grippe adjuster block.
- Fix the boss and wire (B & C) to the boss base plate tuning clockwise.
- Adjust the high of the panel to the desired height using the grippe adjuster block.
- Once the Alpha panel has been levelled and properly suspended trim the excess wire if necessary with wire cutters.

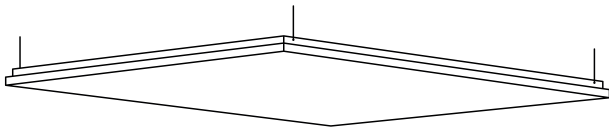

Fig. 9. Hanging Panel

